

Studies of CCDs for Vertex Detector Application

Konstantin Stefanov

Saga University, Japan

On behalf of the JLC Vertex Group:

T. Tsukamoto, Saga University

A. Miyamoto, Y. Sugimoto, KEK

N. Tamura, Niigata University

K. Abe, T. Nagamine, Tohoku University

T. Aso, Toyama National College of Maritime Technology

CCD-based Vertex Detector

OUTLINE

- **Physics requirements (KEK, Saga U):**
 - **Optimal number of CCD layers and their configuration,**
 - **Optimal radius of each CCD layer**

- **Technical requirements:**
 - **Mechanical design (precision support ladders, cooling, etc.) (KEK)**
 - **Radiation damage effects (Saga U, KEK, Tohoku U)**

- **Summary**

Physics requirements

Current CCD vertex detector model:

Four CCD layers at radii 24, 36, 48 and 60 mm

This design has not been optimized

Study is under way to simulate and optimize vertex detector design (KEK and Saga U)

Simulation should take into account:

- **Physics requirements**
- **Constraints of the mechanical support**
- **CCD properties**

Mechanical design studies

Room temperature (25 °C)

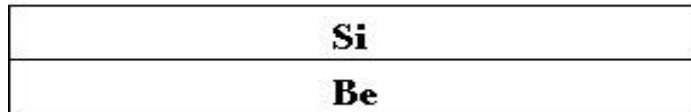

"Near" room temperature (0 °C)

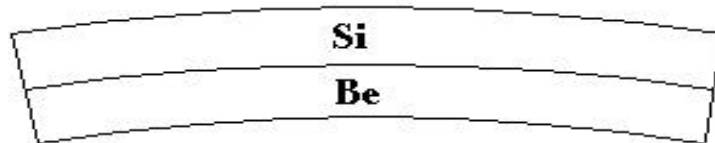

Low temperature (-100 °C)



Coefficients of thermal expansion:

Si : $2.6 \cdot 10^{-6}/^{\circ}\text{C}$ @20°C

Be : $11.3 \cdot 10^{-6}/^{\circ}\text{C}$ @20°C

For a 10 cm long ladder and a 300 mm thick Si wafer:

Cooling causes bowing of 36 mm/°C

- Similar distortion actually happened at SLD
- Cooling to lower temperatures may cause mechanical destruction of the Si wafer

Study of the support structure (Si-Be system) is necessary

Mechanical design studies

Experimental setup

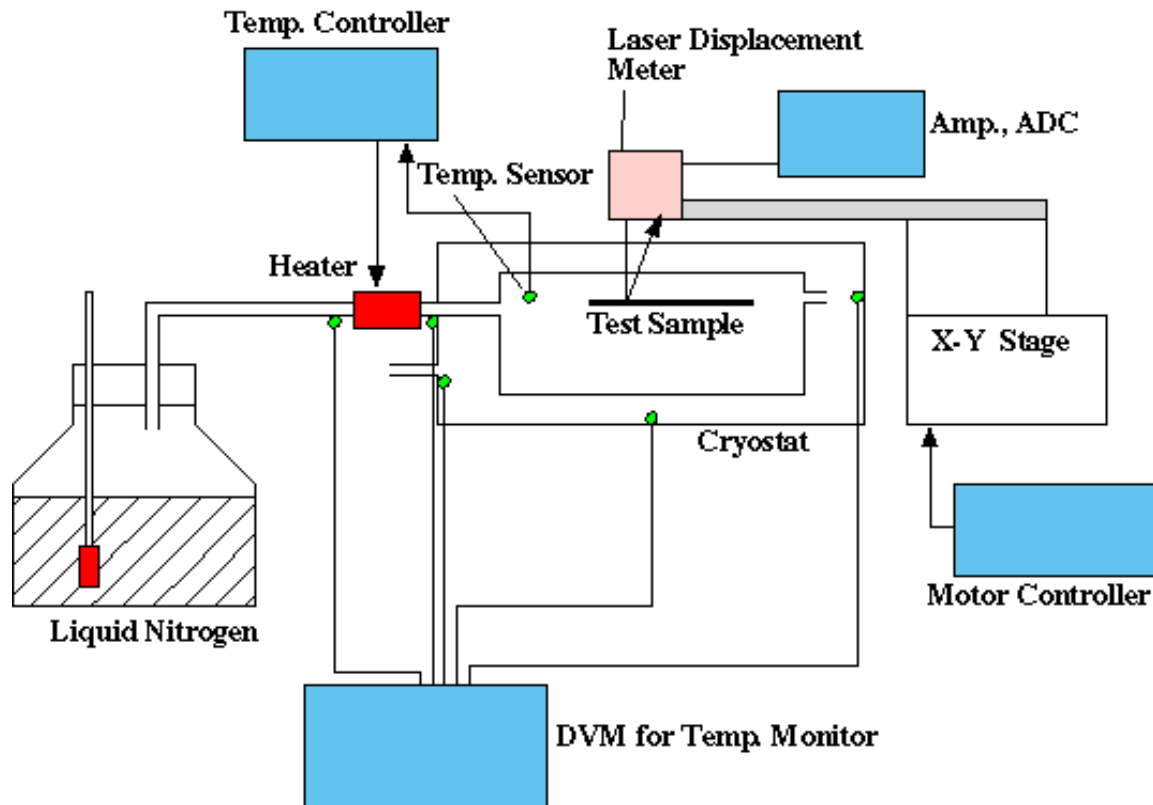

Objectives:

- To measure the thermal distortions of Si wafers (CCDs), mounted on Be ladders,
- To test various mounting techniques and support ladders,
- To gain experience in N₂ vapor cooling.

The cryostat is to be constructed at KEK.

Mechanical design studies

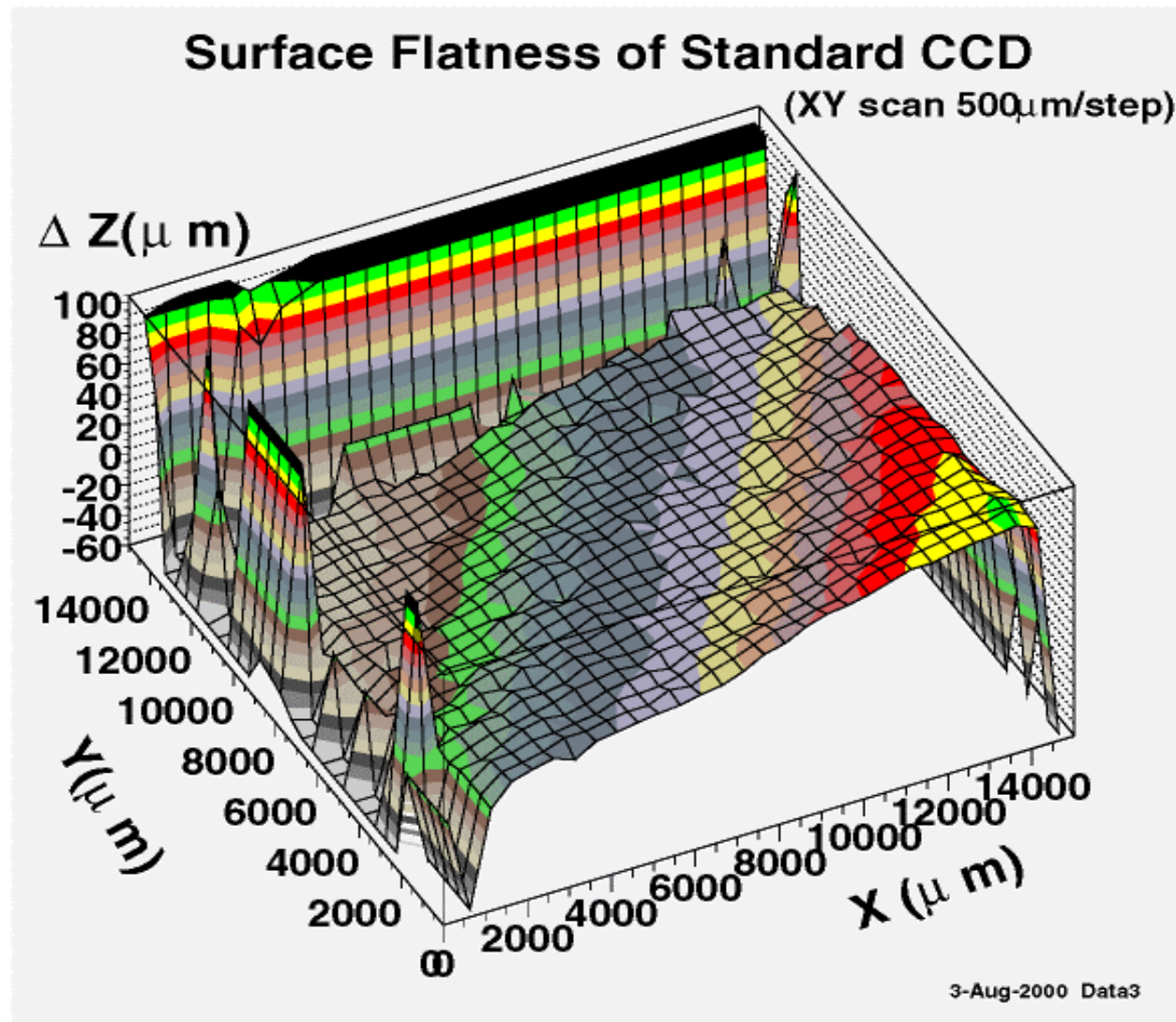

Test measurements of CCDs
(normal and back-thinned) at
KEK

- Precision : 1 mm
- Laser spot diameter : 30 mm
- Mechanical error of the X-Y stage : 5 mm

Mechanical design studies

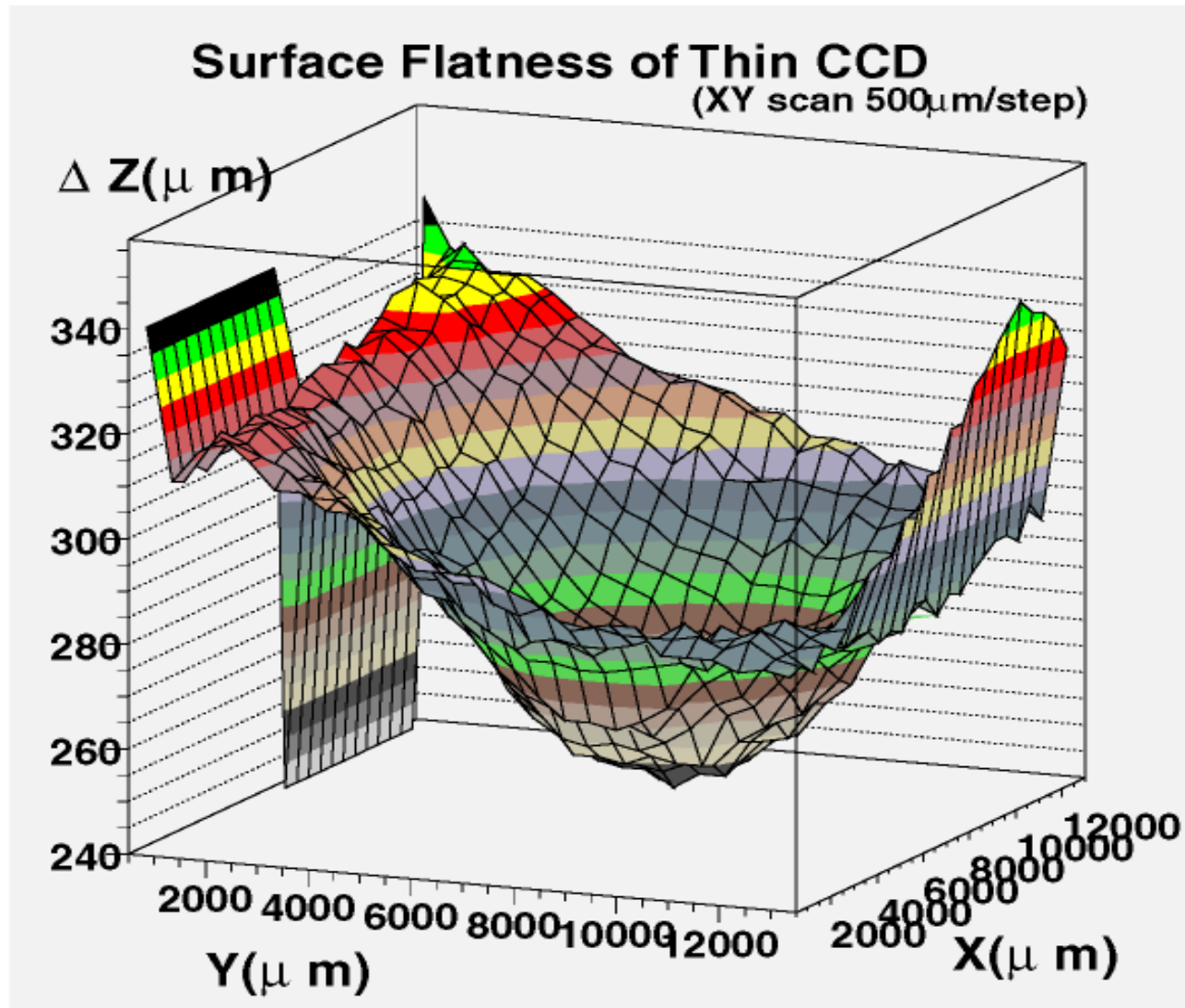

Radiation damage studies

Objectives:

- Study the radiation hardness of commercially available CCDs,
- Compare 2- and 3-phase CCDs in terms of CTI,
- Build a model for the CTI,
- Estimate CCD lifetime in the radiation environment.

Choose device structure and parameters:

- 2- or 3-phase CCD
- notch channel, radiation hard dielectric if necessary
- proper CCD size and pixel number
- readout speed
- operating temperature (as high as possible, use MPP mode CCD's)

Radiation damage studies

Radiation damage effects:

- Buildup of positive charge in the dielectric – limited tolerance
- Increased dark current – bulk and surface generated
- Charge-Transfer Inefficiency (CTI) increases

Pixel with defects

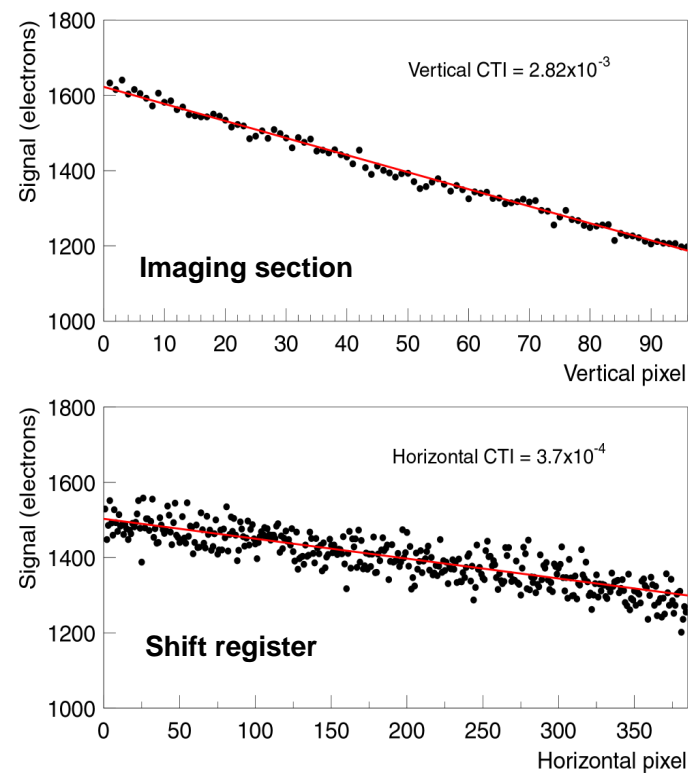
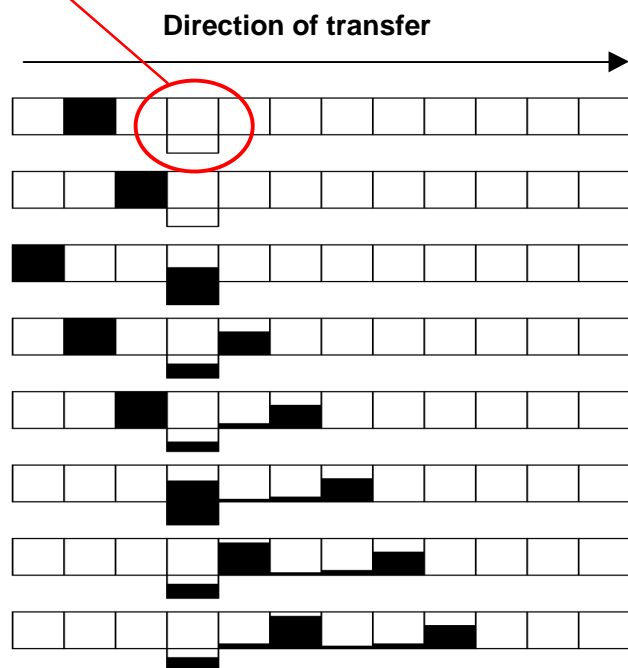

Notch CCD

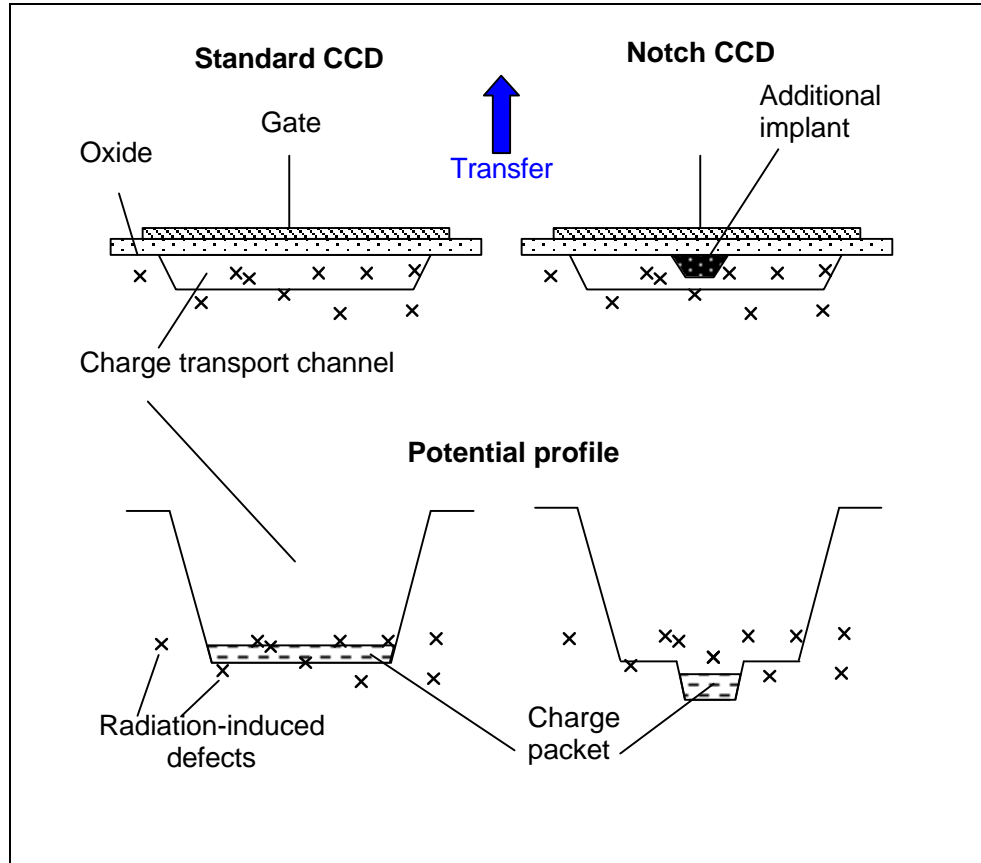

- Additional implant in the channel;
- 'Notch' in the potential profile;
- Small signal packets are transported in the notch;

- $$\text{CTI} \propto \frac{n_t}{n_s},$$

n_t - concentration of defects,

n_s - concentration of signal electrons.

Signal density for small charge packets

increases

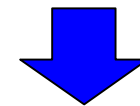

Lower CTI

Notch CCD

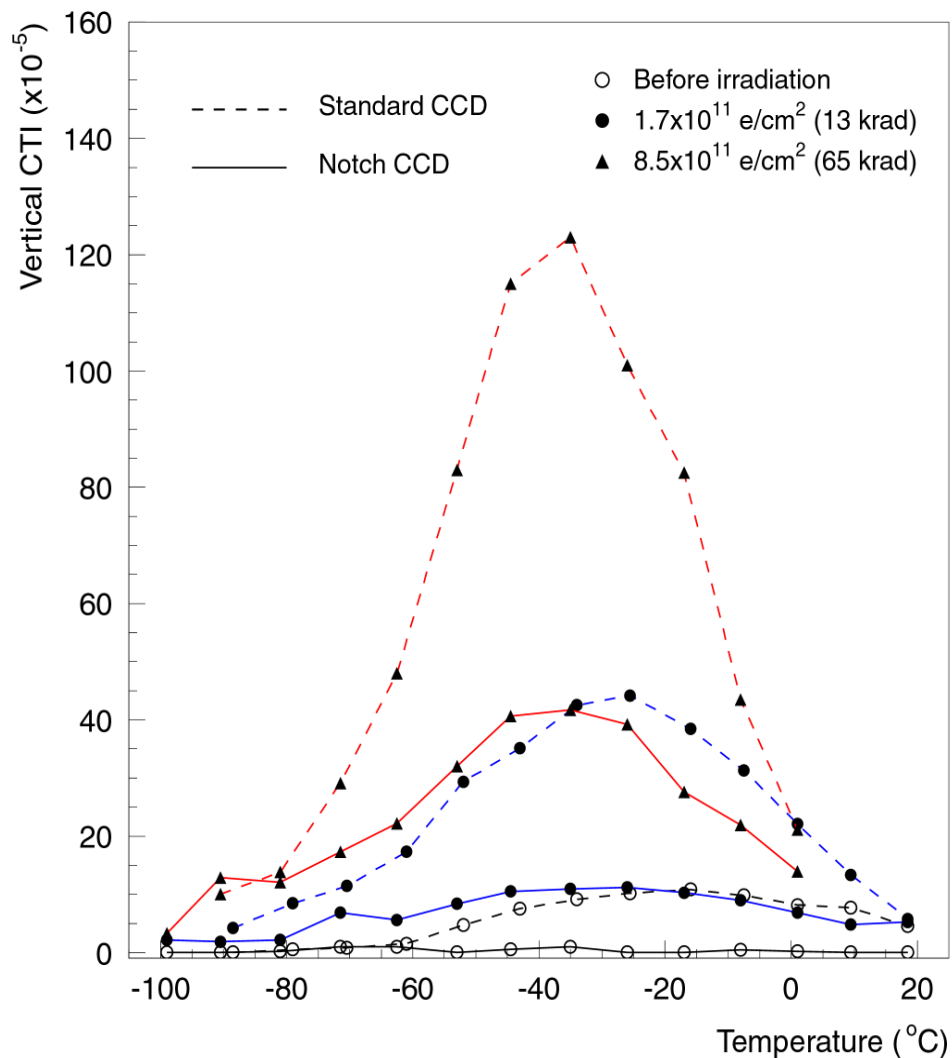

- Hamamatsu Photonics Notch CCD has 3 mm wide additional implant in the channel.

Electron irradiation:

- Vertical (parallel) CTI is about **3** times lower than that in a conventional CCD.

Neutron irradiation:

- Vertical CTI of CCD, irradiated to $5.7 \cdot 10^9$ neutrons/cm² is less than $5 \cdot 10^{-5}$.

Comparison between 2- and 3- phase CCD

In 2-phase CCD signal density is higher  LOWER CTI

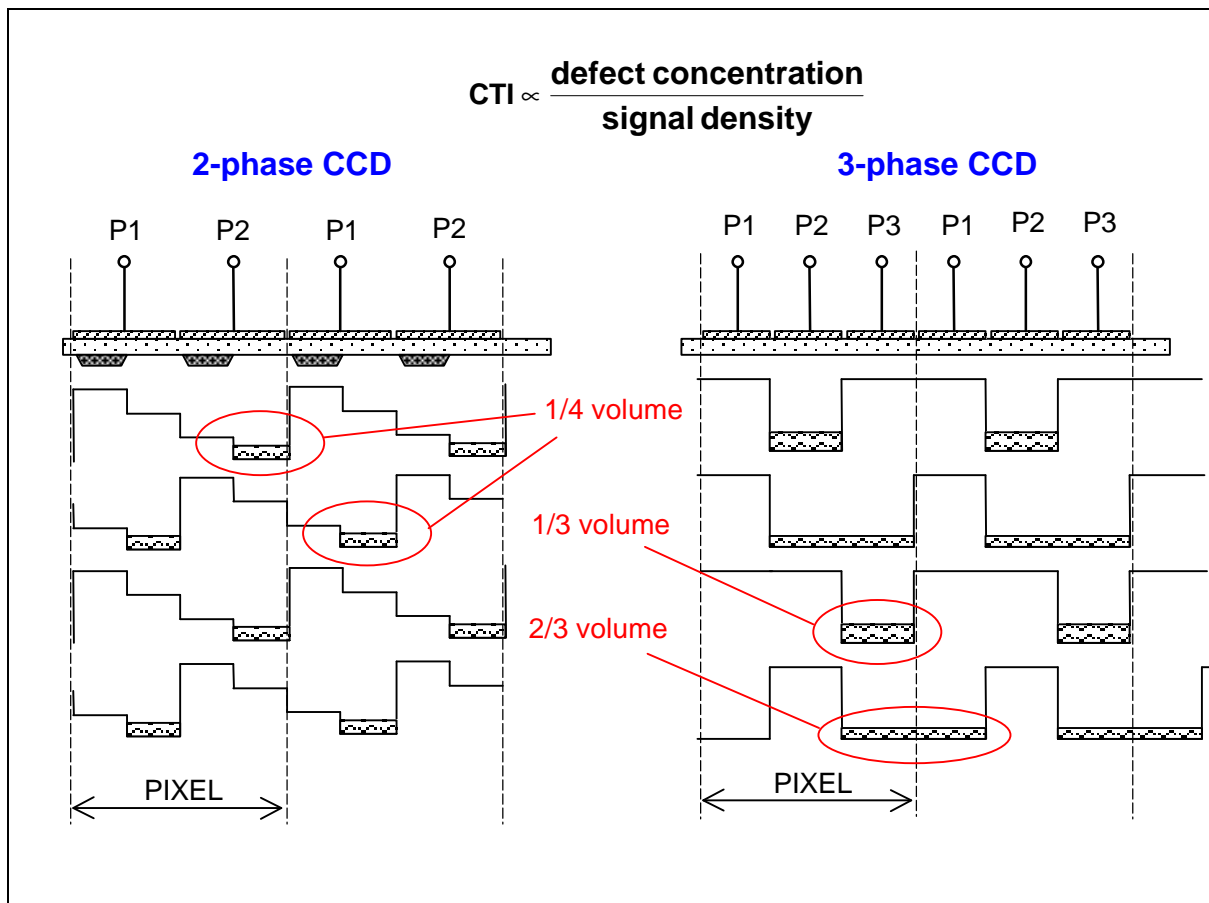

- CTI model for 3-phase CCD has been developed
- CTI model for 2-phase CCD available (published in IEEE Trans. Nucl. Sci., June 2000)
- Vertical CTI is dominant in both CCDs
- VCTI of 3-phase CCD is »2.5 times higher than in 2-phase CCD.

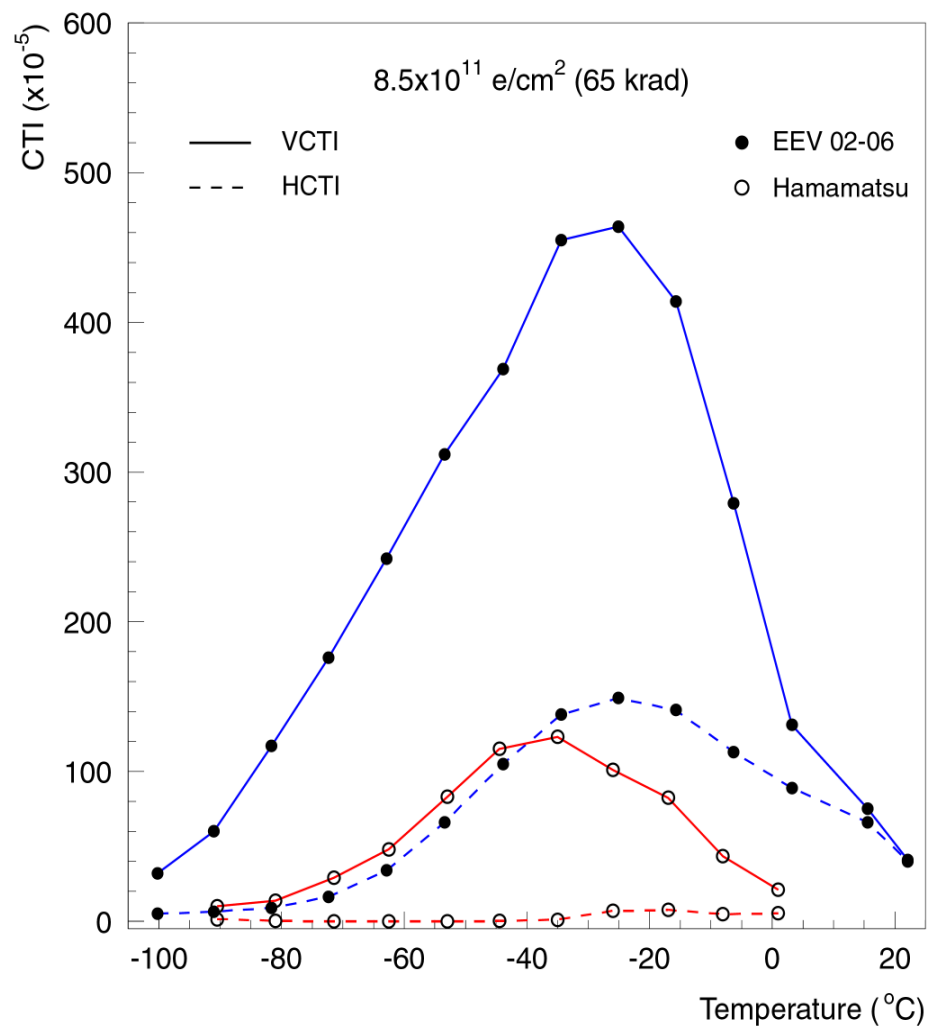

**Experimental comparison
between 2- and 3-phase CCD:**

- Hamamatsu S5466 (2-phase)
- EEV 02-06 (3-phase)

The 2-phase CCD has » **4** times lower
VCTI (*)

(*) Integration time for S5466 3s, for EEV 2s;
DCP in S5466.

CTI simulation

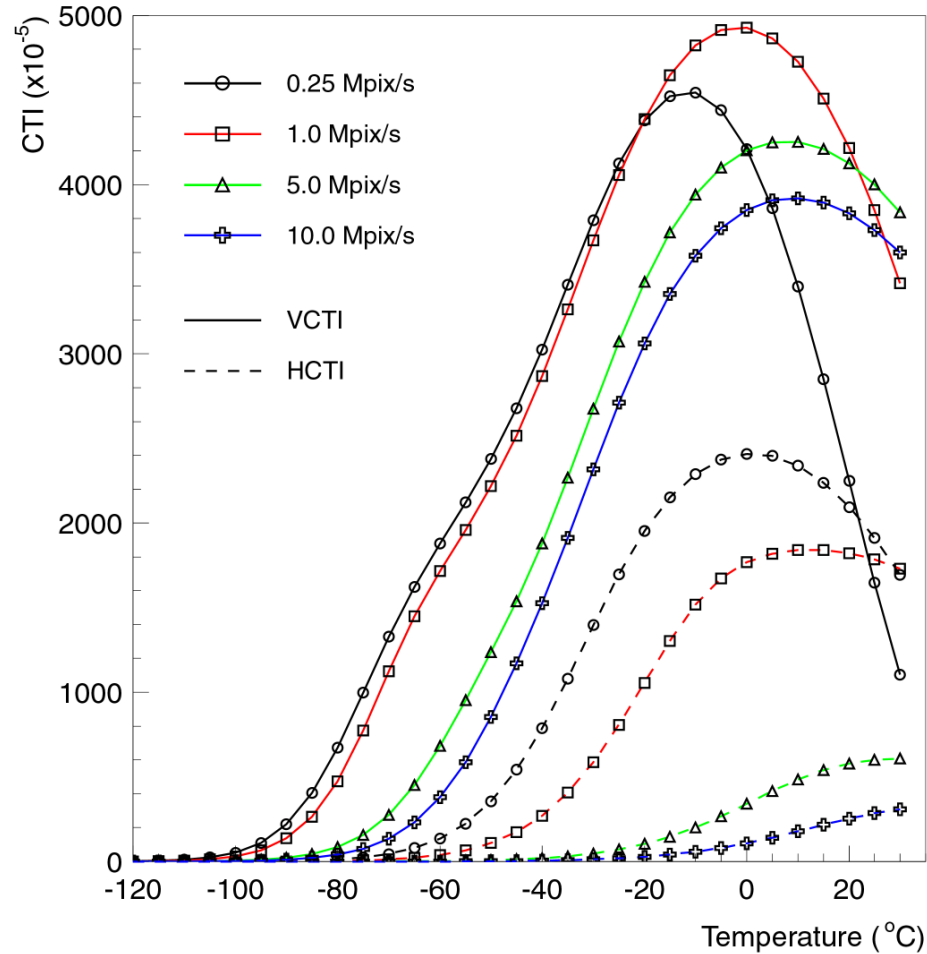

Frequency dependence of CTI

Simulated CTI of a 3-phase CCD, irradiated to $5 \cdot 10^{12}$ electrons/cm² (⁹⁰Sr)

Neutrons (at $5 \cdot 10^9$ neutrons/cm², ²⁵²Cf) cause much smaller CTI.

- Vertical CTI – weak frequency dependence
- Horizontal CTI – very small at high frequencies

Injection of additional charge (fat zero effect)

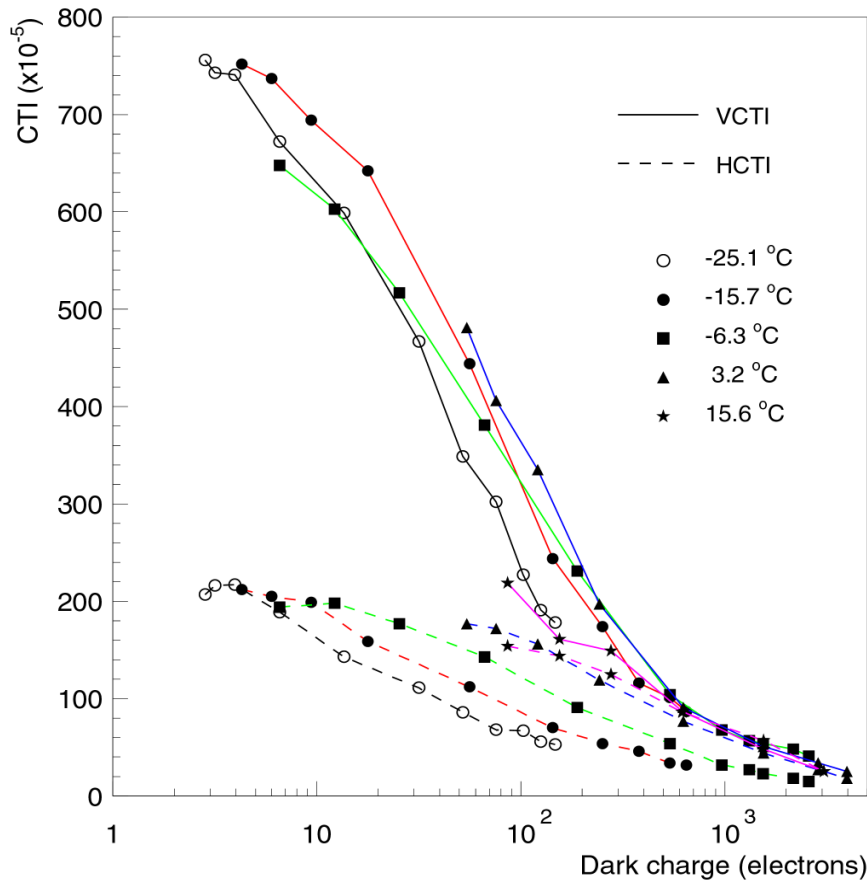

Dark current electrons occupy traps



Less signal electrons are lost

**The most powerful method for
reducing charge losses**

- Injection of 1000 electrons introduces 32 electrons (RMS) noise
- Noise of high speed CCD: about 100 electrons (RMS)
- Requires CCD with an injection structure

Experiment on EEV02-06 CCD: 8 to 10 times CTI reduction

Injection of additional charge (fat zero effect)

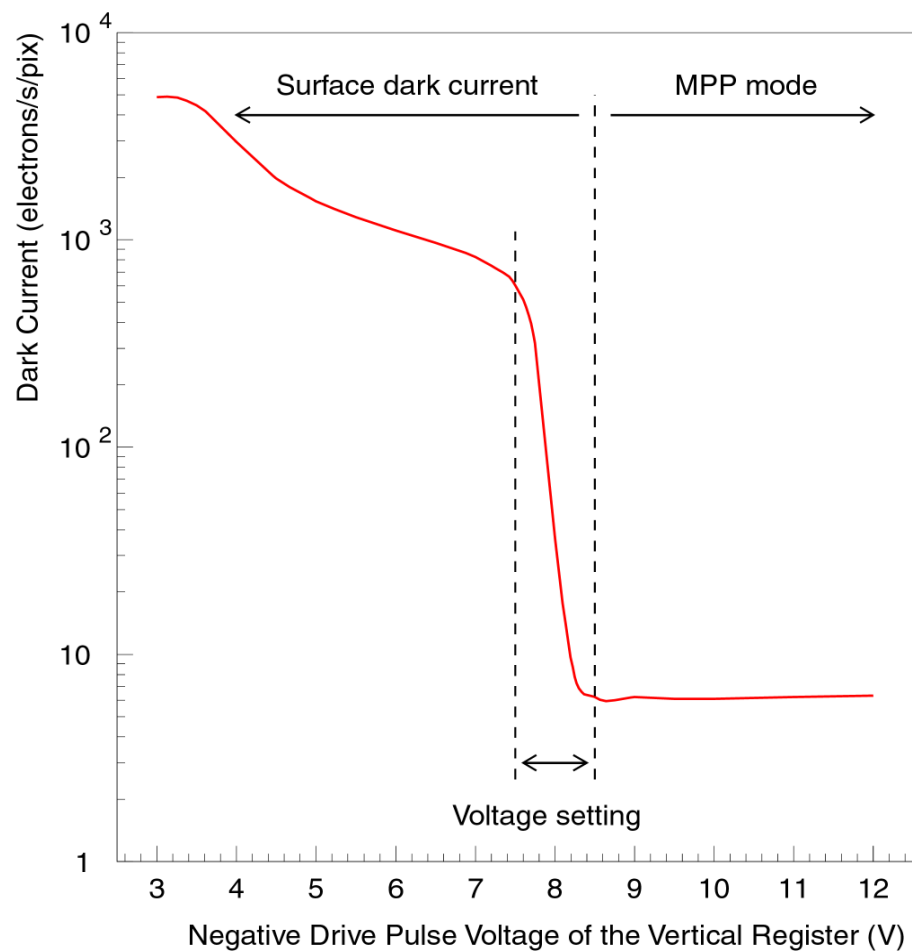

Method for charge injection in the vertical register

- Uses the characteristics of MPP operation

Pros:

- Dark charge is generated thermally
- Works on any type of MPP CCD
- No need for a special device

Cons:

- Requires precise adjustment
- Operation depends on the irradiation level
- Works only at high temperatures

CTI improvements

After 10 years of operation ($\gg 5 \cdot 10^{12}$ electrons/cm² ⁹⁰Sr, and $\gg 5 \cdot 10^9$ neutrons/cm² ²⁵²Cf)

- Vertical CTI reaches $4.8 \cdot 10^{-2}$ (at maximum, 250 kpix/s)
- Horizontal CTI is **much smaller** than the VCTI.
- Neutron irradiation causes **small** CTI.

Budget for improvement:

Option	VCTI improvement
Raise the readout speed to > 5 Mpix/s	$\gg 1.3$ times
Use 2-phase CCD	$\gg 2.5$ times
Use notch CCD	3 to 4 times
Inject dark charge $\gg 1000$ electrons (at > 5 °C)	6 to 8 times
Total improvement :	$\gg 60$ to 100 times

Recent simulation gives $1.5 \cdot 10^{12}$ e⁺e⁻ pairs/cm²/10 years, however their energy is higher than ⁹⁰Sr electrons (safety margin of 10 gives $15 \cdot 10^{12}$ electrons/cm² ⁹⁰Sr).

Model CCD

Based on the present knowledge on radiation damage effects and device architecture

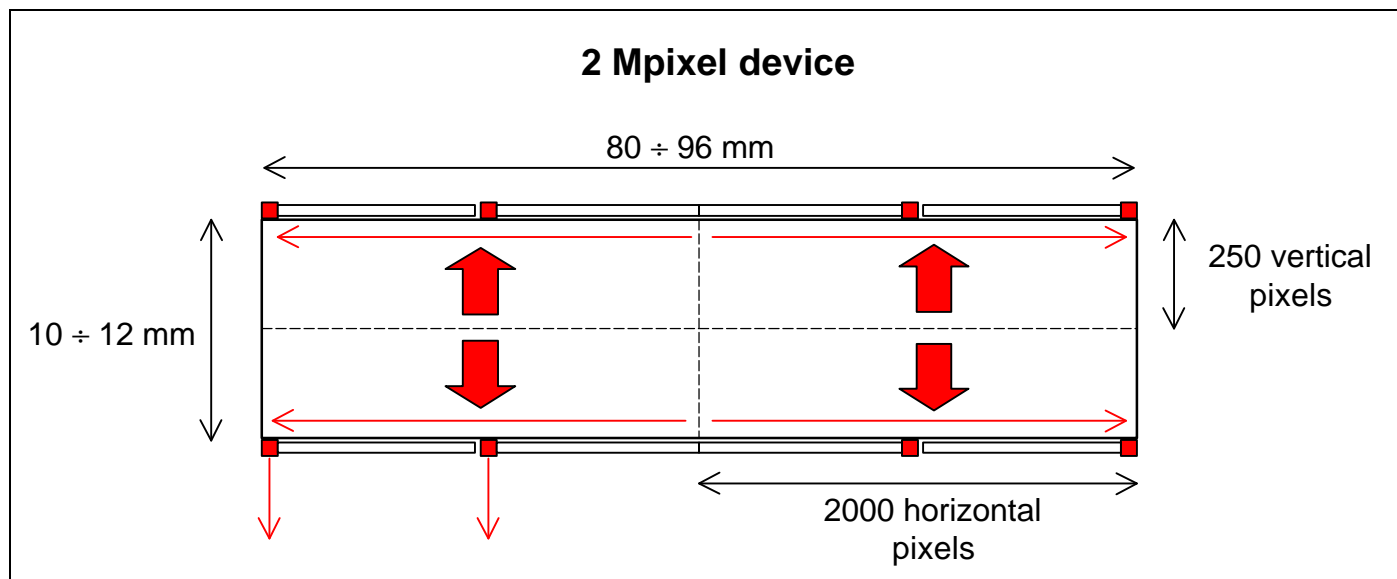

Reduced worst-case CTI:

Vertical CTI to $\gg 8 \cdot 10^{-4}$, output charge after 250 transfers: $(1 - 8 \cdot 10^{-4})^{250} = 0.82$ (18% loss)

Horizontal CTI to $\gg 8 \cdot 10^{-5}$, output charge after 1000 transfers: $(1 - 8 \cdot 10^{-5})^{1000} = 0.92$ (8% loss)

Total charge at the output: $0.82 \cdot 0.92 = 0.75$ (25% loss)

The CCD will survive for 10 years ($\gg 5 \cdot 10^{12}$ electrons/cm² ⁹⁰Sr, $\gg 5 \cdot 10^9$ neutrons/cm² ²⁵²Cf), or for 3 years (at $15 \cdot 10^{12}$ electrons/cm²)

CCD drawbacks (Hamamatsu S5466 2-phase CCD)

Spurious dark current (Dark Current Pedestal, DCP)

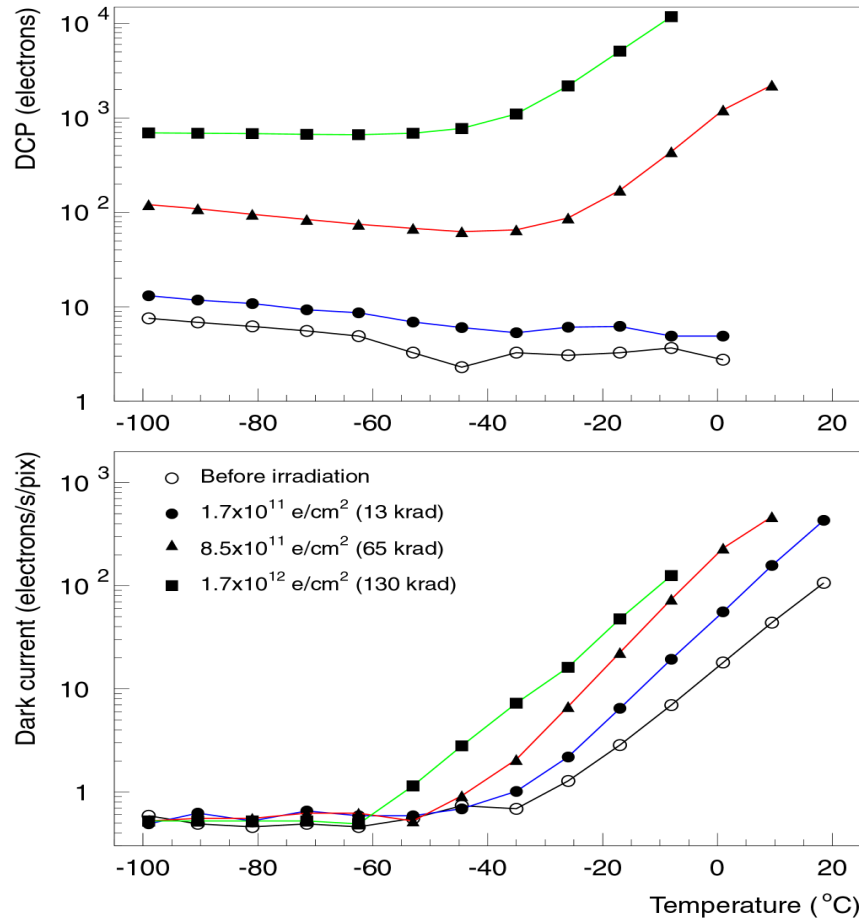

Shift of the MPP threshold voltage and clock voltages

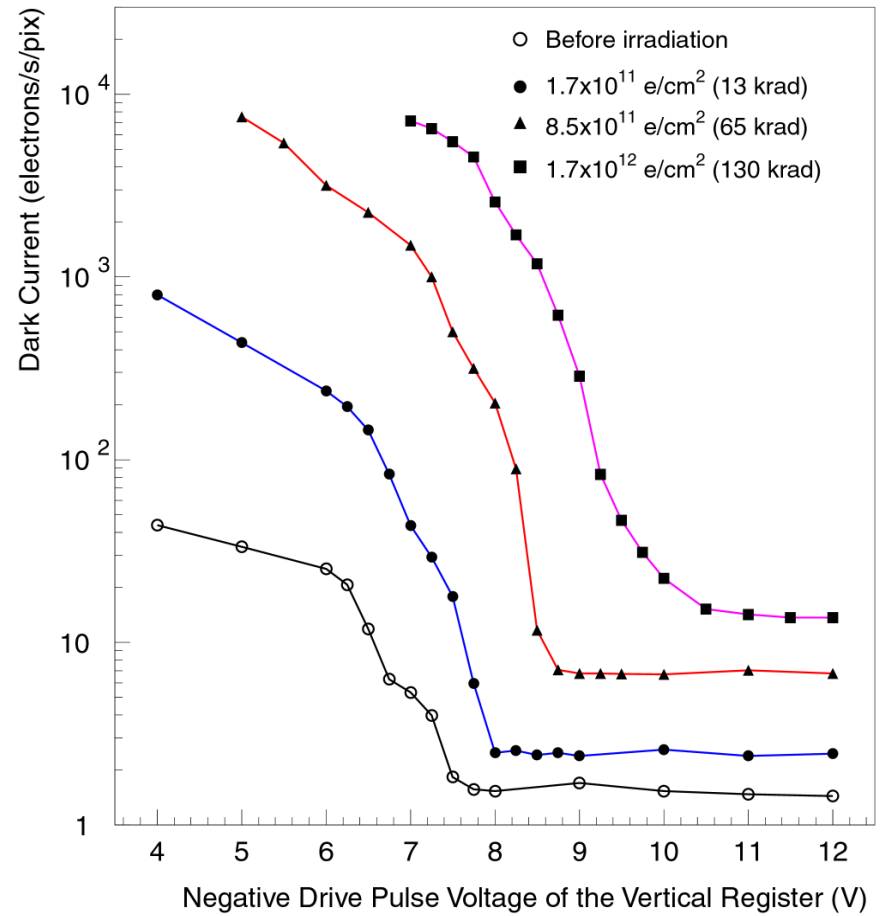

CCD drawbacks

HOT PIXELS

- High dark current, contained in a pixel;
- Created intensively by fast neutrons;
- Present in non-irradiated devices;
- Present in EEV and Hamamatsu CCD's
- Dark current in some hot pixels changes at random:

Random Telegraph Signals (RTS)

Hot pixels in Notch CCD at 3.0°C and integration time of 2 seconds.

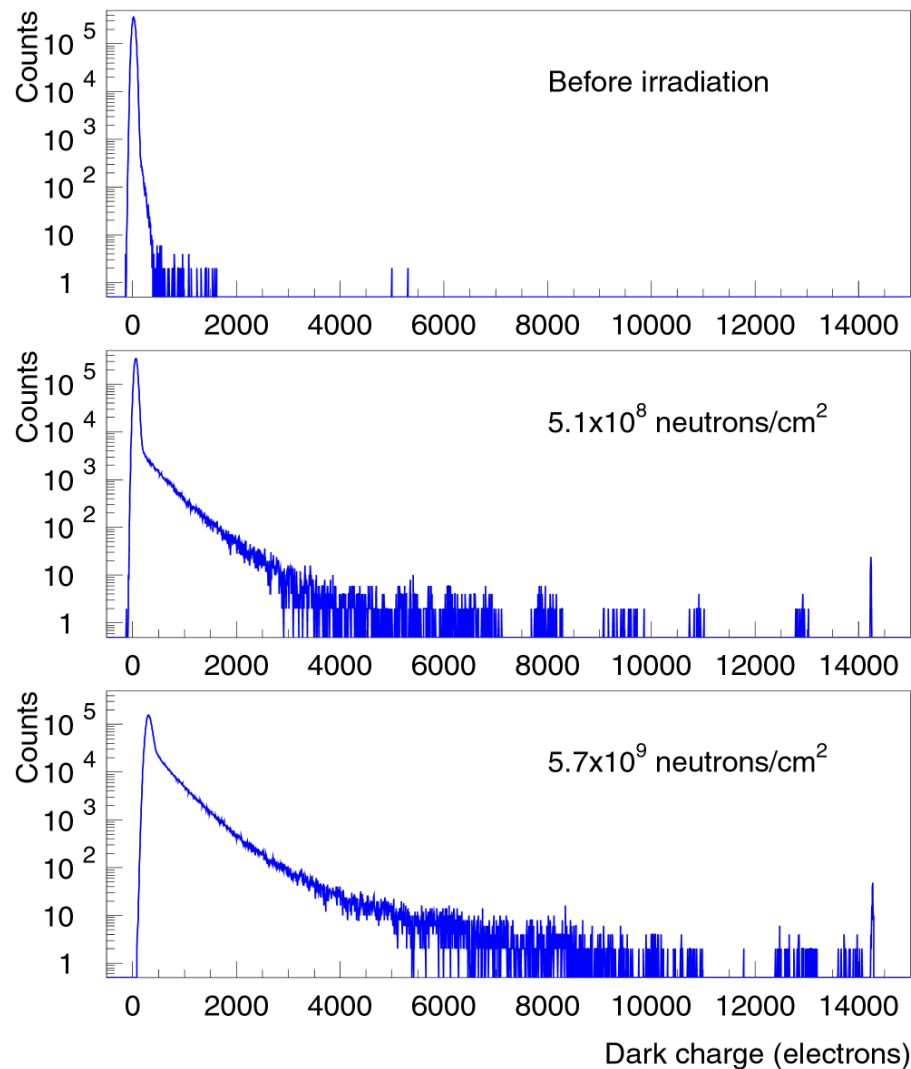

CCD drawbacks

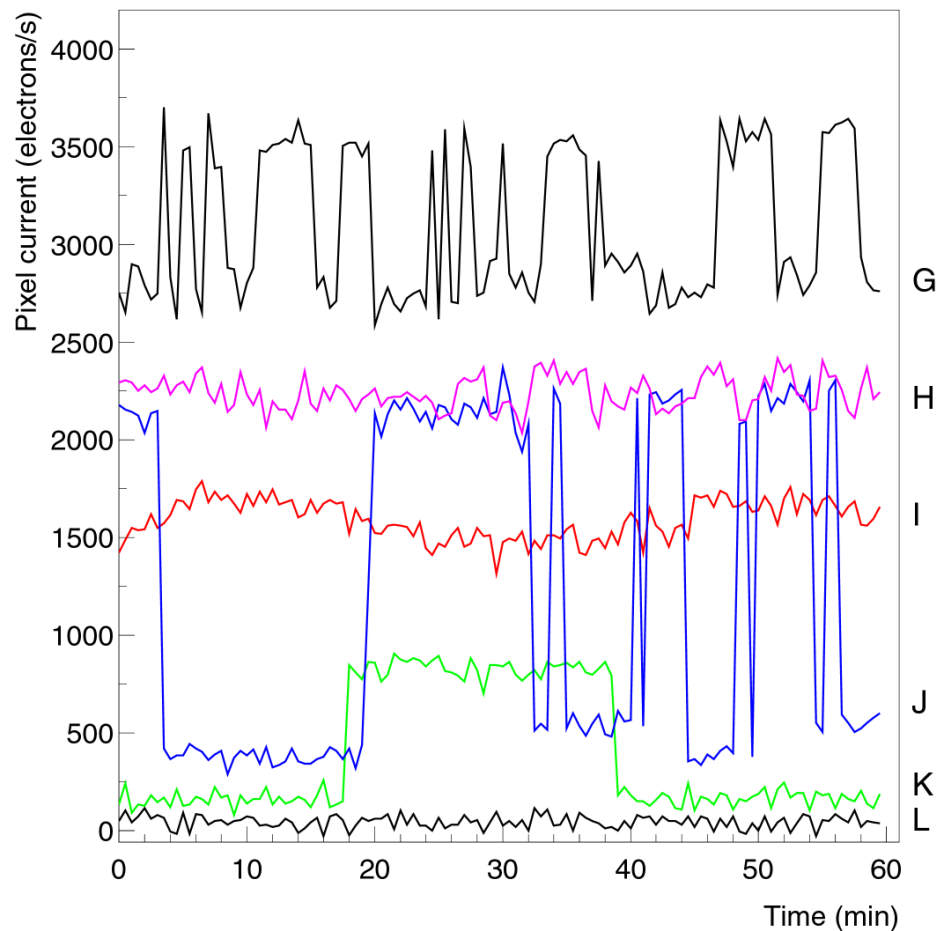

Random Telegraph Signals in hot pixels

Examples of RTS from hot pixels at -1.6°C , Hamamatsu CCD:

- Step-like transitions (K)
- “Chaotic” (G, J)
- “Smooth” transitions (I)
- “Noisy” RTS (H)
- Normal pixel (L)

About 40% of all hot pixels exhibit RTS.

Random Telegraph Signals

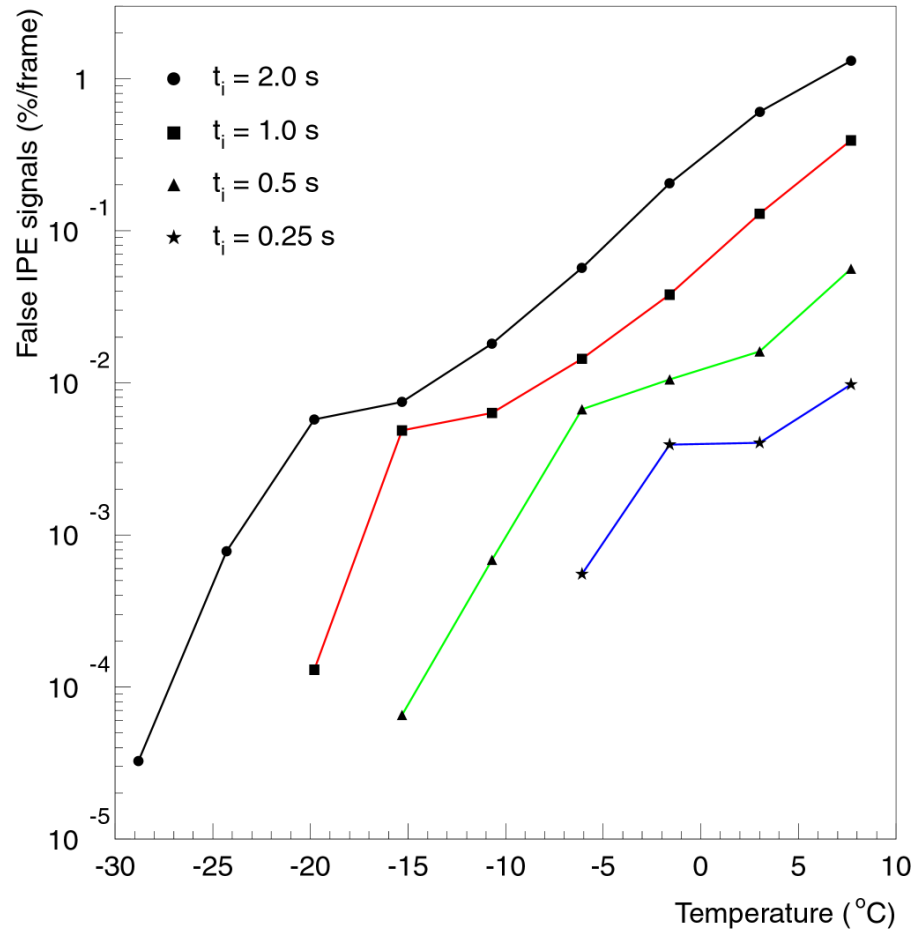

- CCD irradiated to $5.7 \cdot 10^9$ neutrons/cm²;
- RTS cause false isolated pixel signals;
- Threshold = 600 electrons (signal = 1620 electrons);
- 1-hour run at each temperature and integration time;

Some pixels continuously create false signals - CCD should be read out sufficiently fast or cooled down.

With fast readout low occupation can be achieved even around 0°C.

SUMMARY

- **Vertex detector modeling is under way**
- **Mechanical support structure will be studied:**
 - Test measurements already conducted**
 - Wafers and test devices from Hamamatsu Photonics available soon**
 - Thermal distortions of CCD and different support structures will be studied**
- **Radiation damage effects extensively studied:**
 - Notch CCD shows 3 times better CTI than standard devices**
 - Two-phase structure superior to three-phase CCD in terms of CTI**
 - Thermal charge injection promising for reducing the CTI**
 - Voltage shifts and spurious dark current are major drawback**
 - New devices to solve those problems available soon from Hamamatsu Photonics**
- **Vertex detector design will be based on the gained knowledge**